

Focus Mount

LCD Monitor Desktop Mount

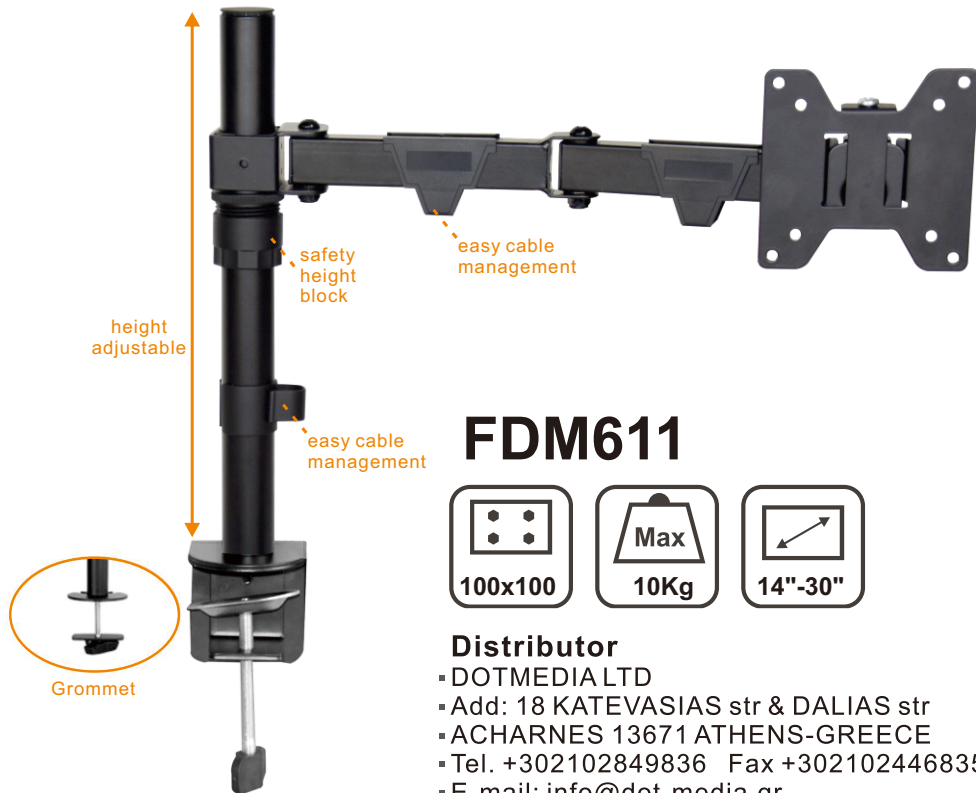

FDM611

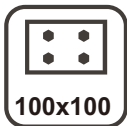

Distributor

- DOTMEDIA LTD
- Add: 18 KATEVASIAS str & DALIAS str
- ACHARNES 13671 ATHENS-GREECE
- Tel. +302102849836 Fax +302102446835
- E-mail: info@dot-media.gr

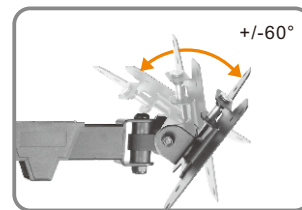

Tilt

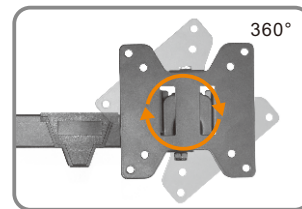

Rotation

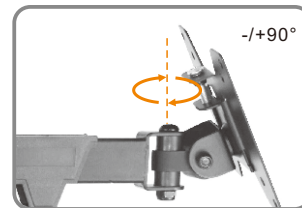

Swivel



