

2MP Mini Fixed Bullet Network Camera

IPC-B122-APF28(40)K

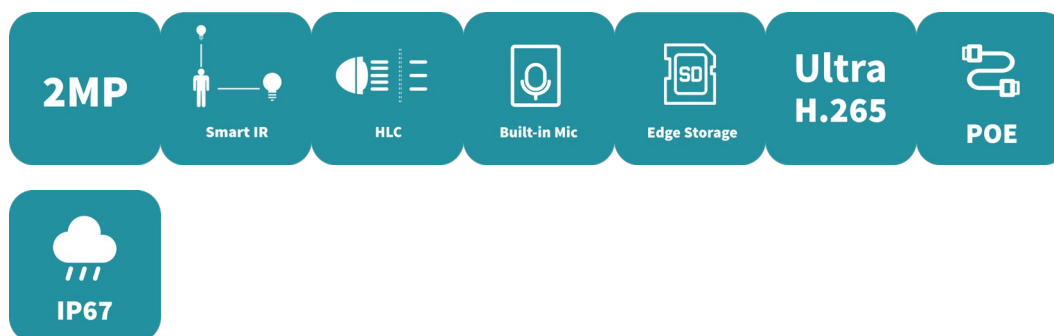

Features

- High quality image with 2MP, 1/2.9" CMOS sensor
- 2MP(1920*1080)@25/20fps; 720P (1280*720) @25/20fps
- Ultra 265, H.265, H.264
- 2D/3D DNR (Digital Noise Reduction)
- ROI (Region of Interest)
- ONVIF Conformance
- Smart IR, up to 30m (98ft) IR distance
- Support 128 GB Micro SD card
- 3-Axis
- Built-in Mic
- Wide temperature range: -30° C ~ 60° C (-22° F ~ 140° F)

- DC12V or PoE(IEEE 802.3af) power supply
- IP67

Specifications

Camera	Description
Resolution	2MP
Sensor	1/2.9"CMOS
Min. Illumination	Colour: 0.02Lux (F2.1, AGC ON) 0 Lux with IR on
Day/Night	IR-cut filter with auto switch (ICR)
Shutter	Auto/Manual, 1 ~ 1/100000s
Adjustment angle	Pan: 0° ~ 360° , Tilt: 0° ~ 90° , Rotate: 0° ~ 360°
S/N	>52dB
WDR	DWDR
Lens	Description
Lens type	IPC-B122-APF28K:2.8mm IPC-B122-APF40K:4.0mm
Iris Type	Fixed
Iris	F2.1
Field of View (H)	IPC-B122-APF28K:101.1° IPC-B122-APF40K:83.7°
Field of View (V)	IPC-B122-APF28K:55.0° IPC-B122-APF40K:44.6°
Field of View (D)	IPC-B122-APF28K:111.0° IPC-B122-APF40K:89.1°
DORI	Description
DORI Distance (Lens)	IPC-B122-APF28K:2.8mm IPC-B122-APF40K:4.0mm
DORI Distance (Detect)	IPC-B122-APF28K:45.0(147.6ft) IPC-B122-APF40K:64.3(210.9ft)
DORI Distance (Observe)	IPC-B122-APF28K:18.0(59.1ft) IPC-B122-APF40K:25.7(84.4ft)
DORI Distance (Recognize)	IPC-B122-APF28K:9.0(29.5ft) IPC-B122-APF40K:12.9(42.2ft)
DORI Distance (Identify)	IPC-B122-APF28K:4.5(14.8ft) IPC-B122-APF40K:6.4(21.1ft)
Illuminator	Description
Illumination Distance(IR)	Up to 30m (98ft)
Wavelength	850nm
IR On/Off Control	Auto/Manual

Video	Description
Video Compression	Ultra 265; H.265; H.264
H.264 code profile	Baseline profile, Main profile, High profile
Frame Rate	Main Stream: 1080P (1920*1080), Max 25fps; 720P (1280*720), Max 25fps; Sub Stream: D1 (720*576), Max 25fps; 640*360,Max 25fps; 2CIF(704*288), Max 25fps; CIF(352*288), Max 25fps;
Video Bit Rate	128 Kbps~6144 Kbps
U-code	Support
OSD	Up to 4 OSDs
Privacy Mask	Up to 4 areas
ROI	Up to 8 areas
Video stream	Dual streams
Image	Description
White Balance	Auto; Outdoor; Fine Tune; Sodium Lamp; Locked; Auto2
Digital noise reduction	2D/3D DNR
Smart IR	Support
Flip	Normal; Flip Vertical; Flip Horizontal; 180°
Dewarping	N/A
HLC	Support
BLC	Support
Defog	Digital Defog
Events	Description
Basic Detection	Motion detection; Audio detection
General Function	Watermark; IP Address Filtering; Access Policy; ARP Protection; RTSP Authentication; User Authentication; HTTP Authentication
Audio	Description
Audio Compression	G.711U; G.711A
Audio Bitrate	64 Kbps
Two-way Audio	N/A
Suppression	Support
Sampling Rate	8KHZ
Storage	Description
Edge Storage	Micro SD, up to 128 GB
Network Storage	ANR
Network	Description
Protocols	IPv4; IGMP; ICMP; TCP; UDP; DHCP; RTP; RTSP; RTCP; RTMP; DNS; DDNS; NTP; UPnP; HTTP; HTTPS; QoS
Compatible Integration	ONVIF (Profile S, Profile G, Profile T); API
User/Host	Up to 32 users, 2 user levels: administrator and common user
Client	Uniarch Client; Uniarch app
Web Browser	Plug-in required live view: IE 10 and above, Chrome 45 and above, Firefox 52 and above, Edge 79 and above; Plug-in free live view: Chrome 57.0 and above, Firefox 58.0 and

	above, Edge 16 and above
Interface	Description
Audio I/O	N/A
Alarm I/O	N/A
Built-in Mic	Support
Built-in Speaker	N/A
WIFI	N/A
Network	1 * RJ45 10M/100M Base-TX Ethernet
Video Output	N/A
Certification	Description
EMC	CE-EMC (EN 55032, EN 61000-3-3, EN IEC 61000-3-2, EN 55035) FCC (FCC 47 CFR part15 B)
Safety	CE LVD (EN 62368-1) CB (IEC 62368-1)
Environment	CE-RoHS (2011/65/EU;(EU)2015/863); WEEE (2012/19/EU);
Protection	IP67 (IEC 60529)
General	Description
Power	DC 12V ±25%, PoE (IEEE 802.3af) Power consumption: Max 3.2W
Power Interface	Ø 5.5mm coaxial power plug
Dimensions	160 × 62 × 65mm (6.3" × 2.4" × 2.6")
Weight	0.21kg (0.46lb)
Working Environment	-30 ° C ~ 60 ° C (-22 ° F ~ 140 ° F), Humidity: ≤95% RH (non-condensing)
Storage Environment	-30 ° C ~ 60 ° C (-22 ° F ~ 140 ° F), Humidity: ≤95% RH (non-condensing)
Surge protection	4KV
Reset button	N/A

Dimensions

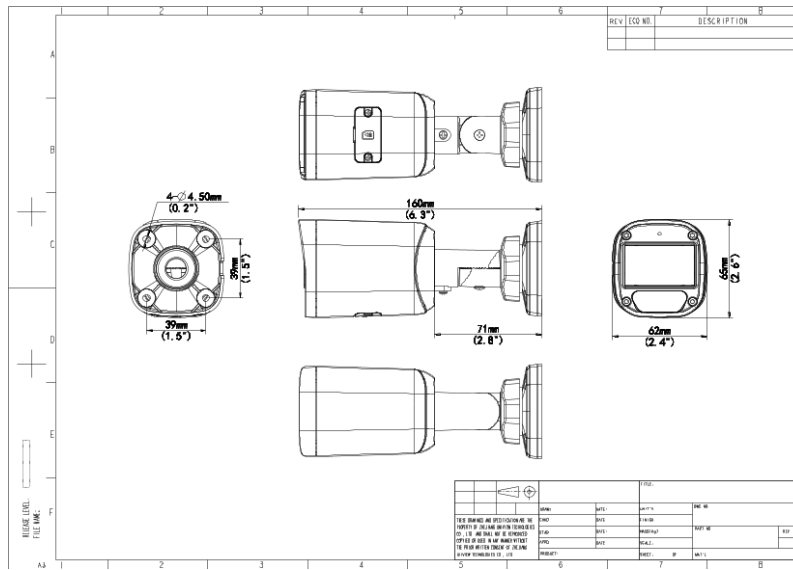

Accessories

TR-JB05-A-IN

Small Bullet Junction Box(Support wiring from behind,Square)



TR-UP06-B-IN

Bullet Pole Mounting Bracket

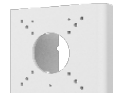

TR-UP06-C-IN

Pole Mounting Bracket for Bullet Junction Box Only

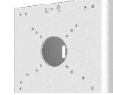

TR-A01-IN

NPT 3/4" Waterproof Cable Gland

TR-UC08-C

Bullet&Dome Corner Mounting Bracket

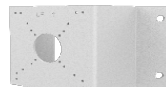

Zhejiang Uniview Technologies Co., Ltd.

No. 369, Xietong Road, Xixing Sub-district, Binjiang District, Hangzhou City, 310051, Zhejiang Province, China

Email: overseasbusiness@uniview.com; globalsupport@uniview.com

<http://www.uniview.com>

©2024 Zhejiang Uniview Technologies Co., Ltd. All rights reserved.

*Product specifications and availability are subject to change without notice.

*Despite our best efforts, technical or typographical errors may exist in this document. Uniview cannot be held responsible for any such errors and reserves the right to change the contents of this document without prior notice.



Hangzhou TDT Technologies Co., Ltd.
Room 101, Building 3, No. 12, Binwen Road,
XixingStreet,Binjiang district, Hangzhou, Zhejiang, China
Telephone +86571-88317620
Telefax +86571-88316350

CE EMC Certification of Conformity

Certificate No.: JCZS(E)20230412021-C

The samples of the below product have been found to comply with the essential requirements of the relevant standards.

Product : IP Camera
Type Designation/Trademark : See Annex
Applicant : Zhejiang Uniview Technologies Co., Ltd.
Address : 1-3/F Area A and 2/F Area B, Building 2;1-11/F South Tower, Building 10, 88 Jiangling Road, Xixing Town, Binjiang District, Hangzhou City, P.R.China
Manufacturer's Name : Zhejiang Uniview Technologies Co., Ltd.
Manufacturer's Address : 1-3/F Area A and 2/F Area B, Building 2;1-11/F South Tower, Building 10, 88 Jiangling Road, Xixing Town, Binjiang District, Hangzhou City, P.R.China
Measurement Facilities : Hangzhou TDT Technologies Co., Ltd.
Relevant Standard(s) / Specification(S) / Directive(S) : EMC Directive 2014/30/EU
EN 55032:2015+A11:2020+A1:2020
EN 55035:2017+A11:2020
EN IEC 61000-3-2:2019+A1:2021
EN 61000-3-3:2013+A1:2019+A2:2021



Accreditations : A2LA Certification number: 4037.01
CNAS Certification number: CNAS L7728

Report Number : JCBG(E)20230412021-C

Issued Date : May 16, 2023

Issued by : Ning Zhang

Position/Title : General Manager

Signature : Ning Zhang





Hangzhou TDT Technologies Co., Ltd.
 Room 101, Building 3, No. 12, Binwen Road,
 Xixing Street, Binjiang district, Hangzhou, Zhejiang, China
 Telephone +86571-88317620
 Telefax +86571-88316350

**This is an Annex to Test Verification of Conformity with Verification/Report Number(S):
 JCBG(E)20230412021-C. The issuing office is Hangzhou TDT Technologies Co., Ltd. (Address:
 Room 101, Building 3, No. 12, Binwen Road, Xixing Street, Binjiang
 district, Hangzhou, Zhejiang, China)**

**Model(s) : IPC-B122-xxxxPxxxx-yyyyyyyyy-zzz, IPC-B124-xxxxPxxxx-yyyyyyyyy-zzz, IPC-B125-
 xxxxPxxxx-yyyyyyyyy-zzz, IPC-B112-xxxxPxxxx-yyyyyyyyy-zzz, IPC-B113-xxxxPxxxx-
 yyyyyyy-zzz, IPC-B114-xxxxPxxxx-yyyyyyyyy-zzz, IPC-B123-xxxxPxxxx-yyyyyyyyy-zzz,
 IPC-B233-xxxxxxxx-yyyyyyyyy-zzz, IPC-B122-APF28K, IPC-B124-APF28K
 (where x,y,z may be blank, one letter or more combination letters from '0-9, A-Z and
 a-z'; '-' is optional)**

**NOTE: This Annex is part of the Test Verification of Conformity and should be read in conjunction with
 it.**

This Verification is for the exclusive use of TDT's Client and is provided pursuant to the agreement between
 TDT and its Client. TDT's responsibility and liability are limited to the terms and conditions of the agreement.
 TDT assumes no liability to any party, other than to the Client in accordance with the agreement, for any loss,
 expense or damage occasioned by the use of this Verification. Only the Client is authorized to copy or
 distribute this Verification. Any use of the TDT name or one of its marks for the sale or advertisement of the
 tested material, product or service must first be approved in writing by TDT. The observations and test results
 referenced from this Verification are relevant only to the sample tested. This Verification by itself does not imply
 that the material, product, or service is or has ever been under an TDT certification program.

Issued Date : May 16, 2023

Issued by : Ning Zhang

Position/Title : General Manager

Signature : Ning Zhang



VERIFICATION OF COMPLIANCE

No.:	GPSD SHES2405010684AT
Applicant:	Zhejiang Uniview Technologies Co., Ltd. No. 369, Xietong Road, Xixing Sub-district, Binjiang District, Hangzhou City, 310051, Zhejiang Province, China
Manufacturer:	Zhejiang Uniview Technologies Co., Ltd. No. 369, Xietong Road, Xixing Sub-district, Binjiang District, Hangzhou City, 310051, Zhejiang Province, China
Product Name:	IP Camera
Model No.:	See page 2
Trade Mark:	
Rating:	See page 2
Protection against Electric Shock:	Class III
Additional Information (if any):	None
Sufficient samples of the product have been tested and found to be in conformity with	
Test Standard:	EN IEC 62368-1:2020+ A11:2020
as shown in the	
Test Report Number(s):	SHES240501068401

This Verification of Compliance has been granted to the applicant based on the results of tests performed by Laboratory of SGS-CSTC Standards Technical Services Co., Ltd. on sample of the above-mentioned product in accordance with the provisions of the relevant specific standards and the General Product Safety Directive 2001/95/EC.

Andrew Zhai
Technical Manager
SGS-CSTC Standards Technical Services Co., Ltd.

2024-07-10

This document is issued by the Company under its General Conditions of Service accessible at http://www.sgs.com/terms_and_conditions.htm. Attention is drawn to the limitation of liability, indemnification and jurisdiction issues defined therein.

Any holder of this document is advised that information contained hereon reflects the Company's findings at the time of its intervention only and within the limits of Client's instructions, if any. The Company's sole responsibility is to its client and this document does not exonerate parties to a transaction from exercising all their rights and obligations under the transaction documents. Any unauthorized alteration, forgery or falsification of the content or appearance of this document is unlawful and offenders may be prosecuted to the fullest extent of the law.

SGS-CSTC Standards Technical Services Co., Ltd.
16F, Century Yu Hui Mansion, No.73, Fucheng Road, Haidian District, Beijing, 100142, CHINA
www.sgs.com
Member of the SGS Group (SGS SA)

No.:

GPSD SHES2405010684AT

Other information added:

Model list:

- (1) IPC-B122-PF40, IPC-B124-PF40, IPC-B122-APF28, IPC-B122-APF40, IPC-B124-APF28, IPC-B125-APF28, IPC-B233-APF40W, IPC-B122-xxxxPxxxx-yyyyyyyy-zzz, IPC-B124-xxxxPxxxx-yyyyyyyy-zzz, IPC-B125-xxxxPxxxx-yyyyyyyy-zzz, IPC-B112-xxxxPxxxx-yyyyyyyy-zzz, IPC-B113-xxxxPxxxx-yyyyyyyy-zzz, IPC-B114-xxxxPxxxx-yyyyyyyy-zzz, IPC-B233-xxxxxxxx-yyyyyyyy-zzz
- (2) IPC-B123-AF28-A, IPC-B123-xxxxPxxxx-yyyyyyyy-zzz
- (3) IPC-B128-APF28KM, IPC-B128-xxxxxxxx-yyyyyyyy-zzz
- (4) C-50B-AF40K, C-80B-AF40K, C-50B-xxxxxxxx-yyyyyyyy-zzz, C-80B-xxxxxxxx-yyyyyyyy-zzz
- (5) Uho-B1R-M2F3, Uho-B1R-M2F4, Uho-B1R-xxxxxxxx-yyyyyyyy-zzz
- (6) IPC-B233-APF40W, IPC-B233-xxxxxxxx-yyyyyyyy-zzz

('x' can be 0-9, A-Z, a-z or blank; 'y' can be 0-9, A-Z, a-z or blank; 'z' can be 0-9, A-Z, a-z or blank; '-' may be blank)

- (7) IPC-B124-APF28K

Rating:

- (1) 12 Vd.c., 1,0A, POE 48 Vd.c., 0,25A;
- (2) 12 Vd.c., 1,0A;
- (3) 12 Vd.c., 1,0A, POE 48 Vd.c., 0,25A;
- (4) 12 Vd.c., 1,0A, POE 48 Vd.c., 0,25A;
- (5) 12 Vd.c., 1,0A;
- (6) 12 Vd.c., 1,0A, POE 48 Vd.c., 0,25A
- (7) 12 Vd.c., 1,0A, POE 48 Vd.c., 0,25A

Andrew Zhai
Technical Manager



SGS-CSTC Standards Technical Services Co., Ltd.

2024-07-10

This document is issued by the Company under its General Conditions of Service accessible at http://www.sgs.com/terms_and_conditions.htm. Attention is drawn to the limitation of liability, indemnification and jurisdiction issues defined therein.

Any holder of this document is advised that information contained hereon reflects the Company's findings at the time of its intervention only and within the limits of Client's instructions, if any. The Company's sole responsibility is to its client and this document does not exonerate parties to a transaction from exercising all their rights and obligations under the transaction documents. Any unauthorized alteration, forgery or falsification of the content or appearance of this document is unlawful and offenders may be prosecuted to the fullest extent of the law.

SGS-CSTC Standards Technical Services Co., Ltd.
16F, Century Yu Hui Mansion, No.73, Fucheng Road, Haidian District, Beijing, 100142, CHINA
www.sgs.com
Member of the SGS Group (SGS SA)



ΔΗΛΩΣΗ ΣΥΜΜΟΡΦΩΣΗΣ ΕΕ

Nr 2023/01041

Για τα ακόλουθα προϊόντα

εξοπλισμού

: IP Κάμερα

Τύπος Προϊόντος/Εμπορικό

IPC-B122-APF28K

Σήμα:

IPC-T122-APF28K

IPC-D122-PF28K

IPC-P213-AF40KC

IPC-B124-APF28K

IPC-T124-APF28K

IPC-D124-PF28K

IPC-B314-APKZ

IPC-T314-APKZ

IPC-D314-APKZ

IPC-B125-APF28

IPC-T125-APF28

IPC-D125-PF28

IPC-B315-APKZ

IPC-T315-APKZ

IPC-D315-APKZ

Όνομα Κατασκευαστή

: ZHEJIANG UNIVIEW TECHNOLOGIES CO., LTD

Διεύθυνση Κατασκευαστή

No. 369, Xietong Road, Xixing Sub-district,
Binjiang District, Hangzhou City, China (zhejiang)
Pilot Free Trade Zone

στο οποίο αναφέρεται η παρούσα δήλωση, και είναι σύμφωνο με τα ακόλουθα πρότυπα ή άλλα έγγραφα κανονισμού:"

"Οδηγία του Συμβουλίου 2014/30/ΕΕ - Οδηγία EMC"

EN 55032:2015+A11:2020+A1:2020

EN 50130-4:2011+A1:2014

EN IEC 61000-3-2:2019+A1:2021

EN 61000-3-3:2013+A1:2019+A2:2021

"Οδηγία του Συμβουλίου 2014/35/ΕΕ - Οδηγία Χαμηλής Τάσης"

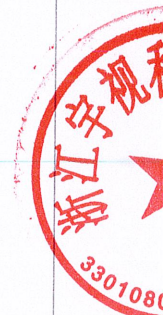

EN IEC 62368-1:2020+A11:2020

"Οδηγία του Συμβουλίου (ΕΕ) 2015/863 τροποποιώντας το Παράρτημα II της Οδηγίας 2011/65/ΕΕ"

"Υπεύθυνος για την κατάθεση αυτής της δήλωσης είναι ο:

Κατασκευαστής Εξουσιοδοτημένος εκπρόσωπος που έχει εγκατασταθεί στην ΕΕ

Υπεύθυνος για την κατάθεση αυτής της δήλωσης

Όνομα, Επίθετο : 白宗杭

Θέση/Τίτλος : Sales Engineer

Hangzhou

2024.07.24

(Μέρος)

(Ημερομηνία)

(Σφραγίδα της εταιρείας και νόμιμη υπογραφή)

